

---

# OWNER'S MANUAL SUPPLEMENT

---

## **ELECTRIC CHAIN HOIST ER2 and NER2 SERIES CYLINDER CONTROL MODEL**

1/8 and 1/4 Ton Capacities

Code, Lot and Serial Number

### **⚠ WARNING**

This equipment should not be installed, operated or maintained by any person who has not read and understood all the contents of this manual. Failure to read and comply with the contents of this manual can result in serious bodily injury or death, and/or property damage.

**HARRINGTON**  
HOISTS AND CRANES

## IMPORTANT INFORMATION ON HOW TO USE THIS MANUAL

This OWNER'S MANUAL SUPPLEMENT is intended for use *in combination* with the “**Owner’s Manual for Electric Chain Hoist ER2 and NER2 Series 1/8 through 5 Ton Capacity**”. Refer to the Table of Contents below to determine the location(s) of information pertaining to your hoist. References to the “Owner’s Manual for Electric Chain Hoist ER2 and NER2 Series 1/8 through 5 Ton Capacity” will be designated by the use of the acronym “**ER2OM**”.

### Table of Contents

<b>Section</b>	<b>Page Number</b>
1.0 Important Information and Warnings .....	ER2OM
1.1 Terms and Summary	ER2OM
1.2 Warning Tags and Labels	ER2OM
2.0 Technical Information.....	4
2.1 Specifications	4
2.2 Dimensions	5
3.0 Preoperational Procedures .....	6 and ER2OM
3.1 Gearbox	ER2OM
3.2 Chain	6
3.3 Mounting Location	7
3.4 Mounting the Hoist	7
3.5 Electrical Connections	7
3.6 VFD Setup (Dual Speed Only)	ER2OM
3.7 Preoperational Checks and Trial Operation	ER2OM
4.0 Operation .....	9 and ER2OM
4.1 Introduction	ER2OM
4.2 Shall's and Shall Not's for Operation	ER2OM
4.3 Hoist Controls	9
5.0 Inspection .....	ER2OM
5.1 General	ER2OM
5.2 Inspection Classification	ER2OM
5.3 Frequent Inspection	ER2OM

<b>Section</b>	<b>Page Number</b>
5.4 Periodic Inspection	ER2OM
5.5 Occasionally Used Hoists	ER2OM
5.6 Inspection Records	ER2OM
5.7 Inspection Methods and Criteria	ER2OM
6.0 Maintenance & Handling .....	ER2OM
6.1 Count/Hour Meter	ER2OM
6.2 Lubrication – Load Chain, Hooks and Suspension	ER2OM
6.3 Lubrication – Gearbox	ER2OM
6.4 Motor Brake	ER2OM
6.5 Load Chain	ER2OM
6.6 Friction Clutch and Mechanical Load Brake with Friction Clutch	ER2OM
6.7 Storage	ER2OM
6.8 Outdoor Installation	ER2OM
7.0 Troubleshooting .....	ER2OM
8.0 Warranty .....	ER2OM
9.0 Parts List .....	10

## 2.0 Technical Information

### 2.1 Specifications

#### 2.1.1 Product Code

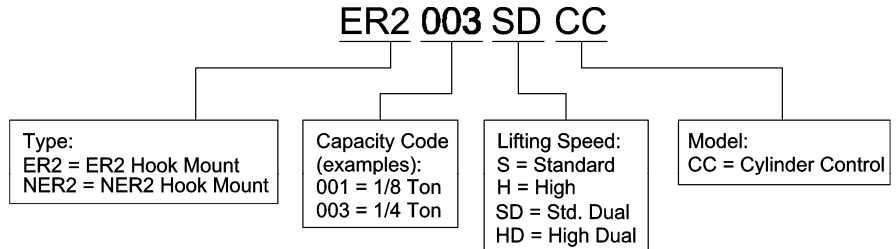

2.1.2 ER2 and NER2 Models - Harrington ER2 series hoist are available in two versions, the ER2 and NER2. These two versions are equipped with different options as standard equipment. The NER2 has a friction clutch mechanism that provides over winding protection. The ER2 has a mechanical load brake/friction clutch combination and an electronic count/hour meter in the control circuit. Refer to [Figure 2-1](#) for the visual differences between the ER2 and NER2.

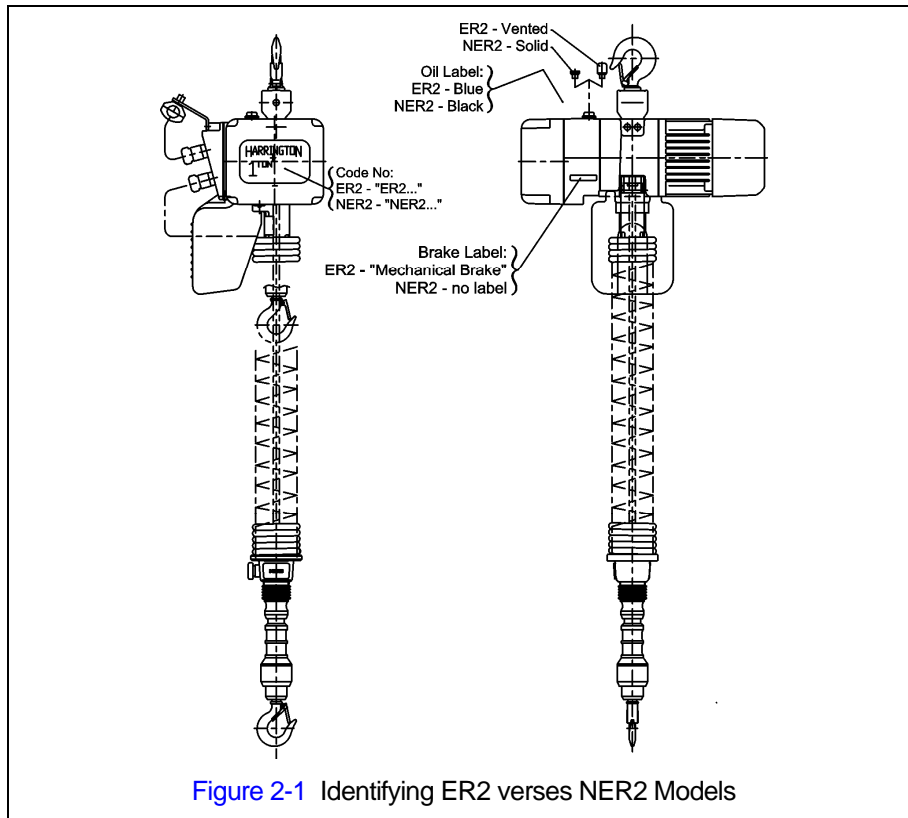

#### 2.1.3 Operating Conditions and Environment

- Temperature range: -4° to +104°F (-20° to +40°C)
- Humidity: 85% or less
- Noise Level: 85 dB or less (A scale: measured 1 meter away from electric chain hoist)
- Enclosure Rating: Hoist Meets IP 55, Cylinder Meets IP44
- Supply Voltage: Single Speed Standard: Reconnectable 208/230 & 460V-3-60

Single Speed Optional: 575V-3-60 or Special Voltages/Frequencies Available

Dual Speed Standard: 208/230V-3-60 or 460V-3-60

Dual Speed Optional: 575V-3-60 or Special Voltages/Frequencies Available

	Single Speed	Dual Speed
Hoist Duty Rating:	ISO M4/M5; ASME H4	
Intermittent Duty Rating:	60% ED	40/20% ED
Short Time Duty Rating:	360 starts per hour	120/240 starts per hour
	60 min.	30/10 min.

## 2.2 Dimensions

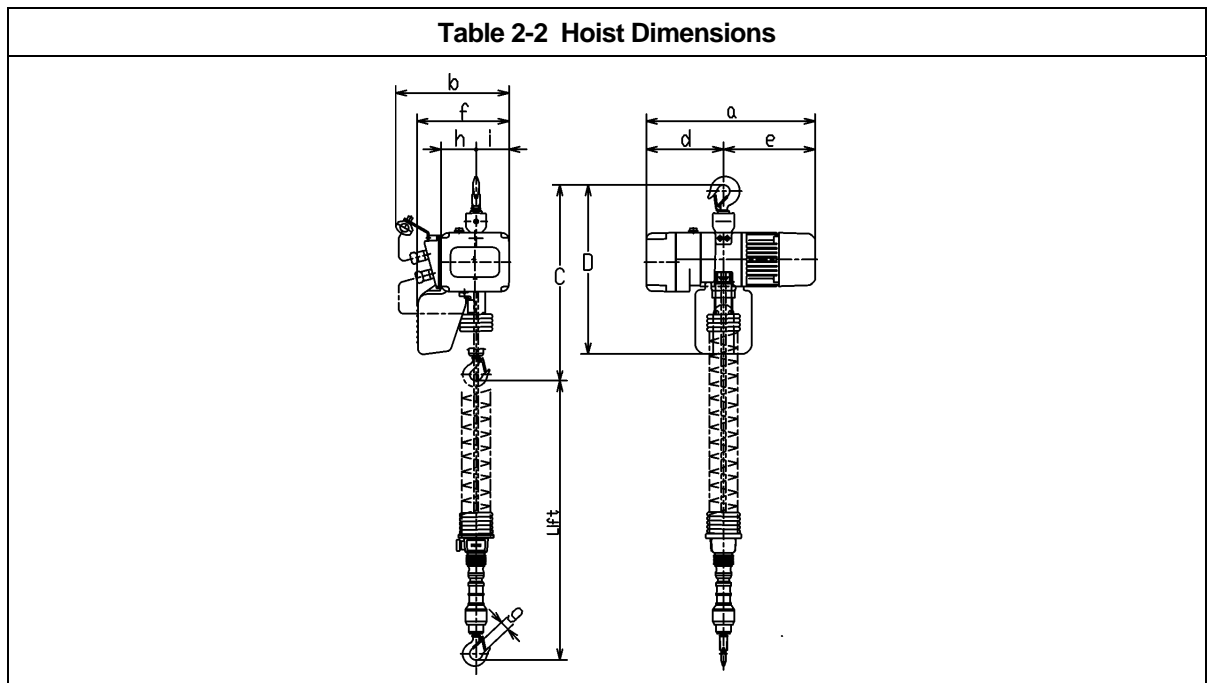

	Cap. (Tons)	Product Code	Headroom C (in)	D (in)	a (in)	b (in)	d (in)	e (in)	f (in)	g (in)	h (in)	i (in)
Single Speed	1/8	NER2001HCC	41.9	19.3	18.8	12.6	8.6	10.2	10.2	0.9	3.9	3.7
	1/4	NER2003SCC	41.9	19.3	18.8	12.6	8.6	10.2	10.2	0.9	3.9	3.7
Dual Speed	1/8	NER2001HDCC	41.9	19.3	21.1	13.6	10.9	10.2	11.2	0.9	3.9	4.6
	1/4	NER2003SDCC	41.9	19.3	21.1	13.6	10.9	10.2	11.2	0.9	3.9	4.6

**Table 2-3 Hook Dimensions**

Capacity Code	Hook**	a (in)	b (in)	c (in)	d (in)	e (in)	f (in)	g (in)
001H, 003S	T	1.1	0.7	0.9	0.7	1.4	1.5	1.1
	B	0.8	0.5	0.7	0.5	1.4	1.4	0.9

## 3.0 Preoperational Procedures

### 3.2 Chain

- 3.2.1 Chain Components – Refer [Figure 3-1](#) and ensure that stoppers and cushion rubbers are in the correct location and properly installed. Never operate the hoist with incorrect, missing or damaged chain components.

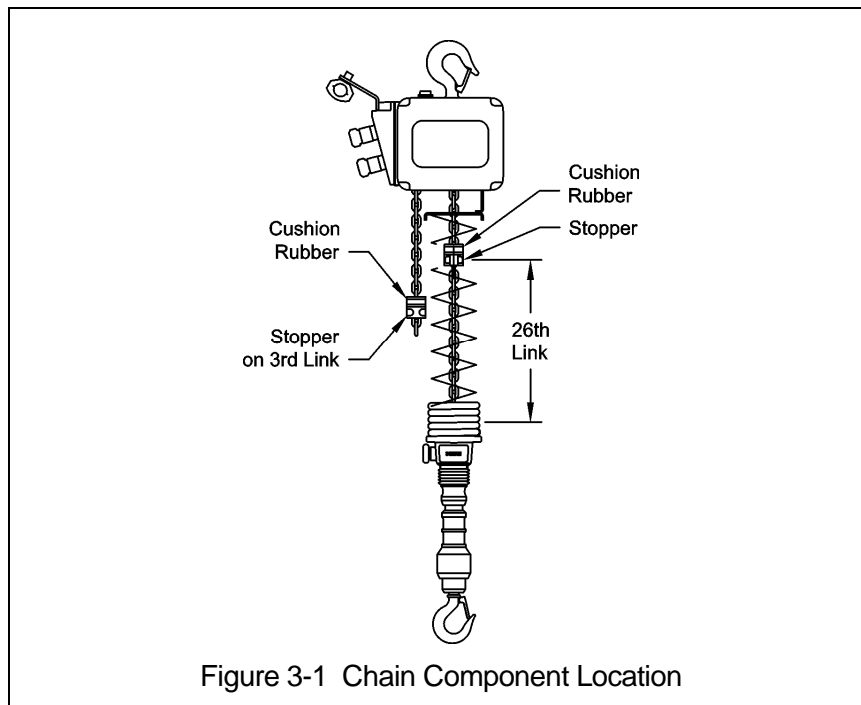

- 3.2.2 Chain Container – Install the chain container on the hoist body as shown in [Figure 3-2](#). To place the chain into the chain container, feed the chain into the chain container beginning with the free end. Take care to avoid twisting or tangling the chain. NEVER put all the chain into the container at once. Lumped or twisted chain may jam against the hoist body activating the friction clutch and potentially damaging the chain.

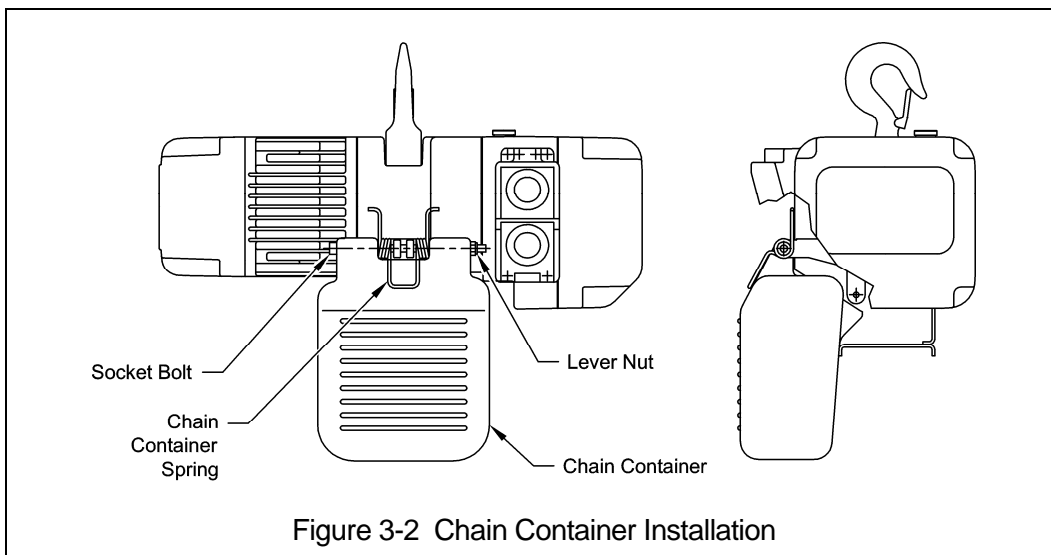

### 3.3 Mounting Location

- 3.3.1 **⚠ WARNING** Prior to mounting the hoist ensure that the suspension and its supporting structure are adequate to support the hoist and its loads. If necessary consult a professional that is qualified to evaluate the adequacy of the suspension location and its supporting structure.
- 3.3.2 **NOTICE** See [Section 6.8](#) of the **ER20M** for outdoor installation considerations.

### 3.4 Mounting the Hoist

- 3.4.1 Manual Trolley - Follow instructions in Owner's Manual provided with the trolley.
- 3.4.2 Motorized Trolley – Cylinder control model hoists are NOT intended to be used with motorized trolleys.
- 3.4.3 Hook Mounted to a Fixed Location - Attach the hoist's top hook to the fixed suspension point.
- 3.4.4 **⚠ CAUTION** Mount the hoist at a height that will allow the operator to maintain a clearance of at least 4 inches (101.6mm) between the Cushion Rubber and the hoist body during operation.
- 3.4.5 **⚠ WARNING** Ensure that the fixed suspension point rests on the center of the hook's saddle and that the hook's latch is engaged.

### 3.5 Electrical Connections

- 3.5.1 **⚠ CAUTION** Ensure that the voltage of the electric power supply is proper for the hoist.
- 3.5.2 **⚠ DANGER** Before proceeding, ensure that the electrical supply for the hoist has been de-energized (disconnected). Lock out and tag out in accordance with ANSI Z244.1 "Personnel Protection -Lockout/Tagout of Energy Sources".
- 3.5.3 Coiled Control Cable - The Coiled Control Cable connects to the hoist via an 8-pin (8P) Plug and Socket. Make this connection as follows:
- Refer to [Figure 3-3](#).
  - Insert the 8P Plug into the 8P Socket on the hoist and hand tighten the Screw Coupling.
- 3.5.4 Power Supply Cable Hoist Connection – The Power Supply Cable connects to the hoist via a 4-pin (4P) plug and socket. Make this connection as follows:
- Refer to [Figure 3-3](#).
  - Insert the 4P plug of the Power Supply Cable into the 4P Socket on the hoist and hand tighten the screw coupling.
  - Install the Cable Support Arm (pre-installed on the Power Supply Cable) on to the Socket Holder using the pre-installed Machine Screws and Lock Washers.  
Use care to avoid twisting or kinking the Power Supply Cable.
- 3.5.5 Power Supply Cable Installation – If the hoist is hook mounted to a fixed support ensure that the Power Supply Cable is properly installed and supported between the hoist and the electrical power supply.
- If the host is installed on a manual trolley, then the Power Supply Cable must be installed along the beam that the trolley runs on. For curved beams a special cable suspension system will be needed, and this instruction does not apply. For straight beams install the Power Supply Cable as follows:
- Install a guide wire system parallel to the beam.
  - For a manual trolley the guide wire should be positioned slightly outside the hoist's Cable Support as shown in [Figure 3-3](#).
  - Use the Cable Trolleys supplied with the hoist to suspend the Power Supply Cable from the guide wire. Space the Cable Trolleys every 5 feet (1.5 meters).

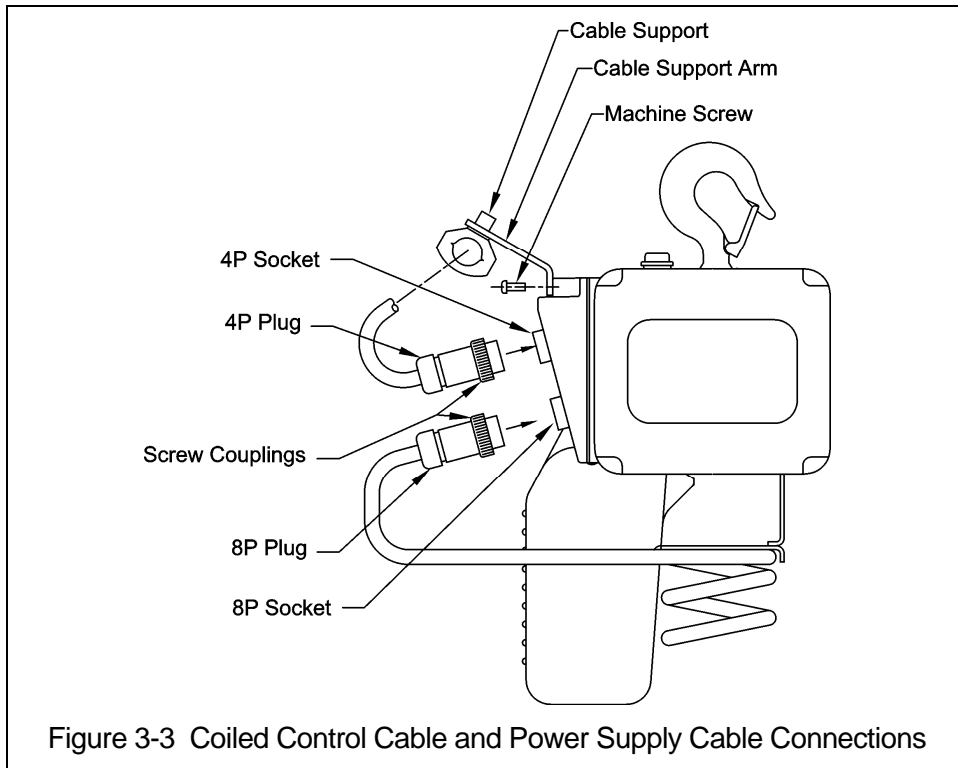

Figure 3-3 Coiled Control Cable and Power Supply Cable Connections

- 3.5.6 Connection to Electrical Power Source - The red, white, and black wires of the Power Supply Cable should be connected to an Electric Power Disconnect Switch or Circuit Breaker. This connection should be made so that the hoist is phased properly. Refer to [Section 3.7.11](#) of the ER2OM for instructions on how to check for correct power supply phase connection.
- 3.5.7 Fuse/Breaker Capacity -The hoist's power supply should be equipped with overcurrent protection such as fuses, which should be selected for 110% to 120% of total listed full load amperage, and should be dual element time-delay fuses. Refer to the motor nameplate for the full load amperage draw.
- 3.5.8 **⚠ DANGER** Grounding - An improper or insufficient ground connection creates an electrical shock hazard when touching any part of the hoist or trolley. In the Power Supply Cable the ground wire will be either Green with Yellow stripe or solid Green. It should always be connected to a suitable ground connection. Do not paint the trolley wheel running surfaces of the beam as this can affect grounding.



## 4.0 Operation

### 4.3 Hoist Controls

- 4.3.1 Single Speed Hoists – Firmly hold the black Grip on the cylinder control. Slide the Up/Down Switch Operator up to raise the load or down to lower the load as shown in Figure 4-1. To stop the hoist slide the Up/Down Switch Operator back to the middle position.
- 4.3.2 Dual Speed Hoists – Select high or low speed using the Speed Selector Switch. Lights adjacent to the Speed Selector Switch indicate if low or high speed is selected. Slide the Up/Down Switch Operator up to raise the load or down to lower the load Figure 4-1. To stop the hoist slide the Up/Down Switch Operator back to the middle position.
- 4.3.3 **⚠ CAUTION** Make sure the motor completely stops before reversing direction.

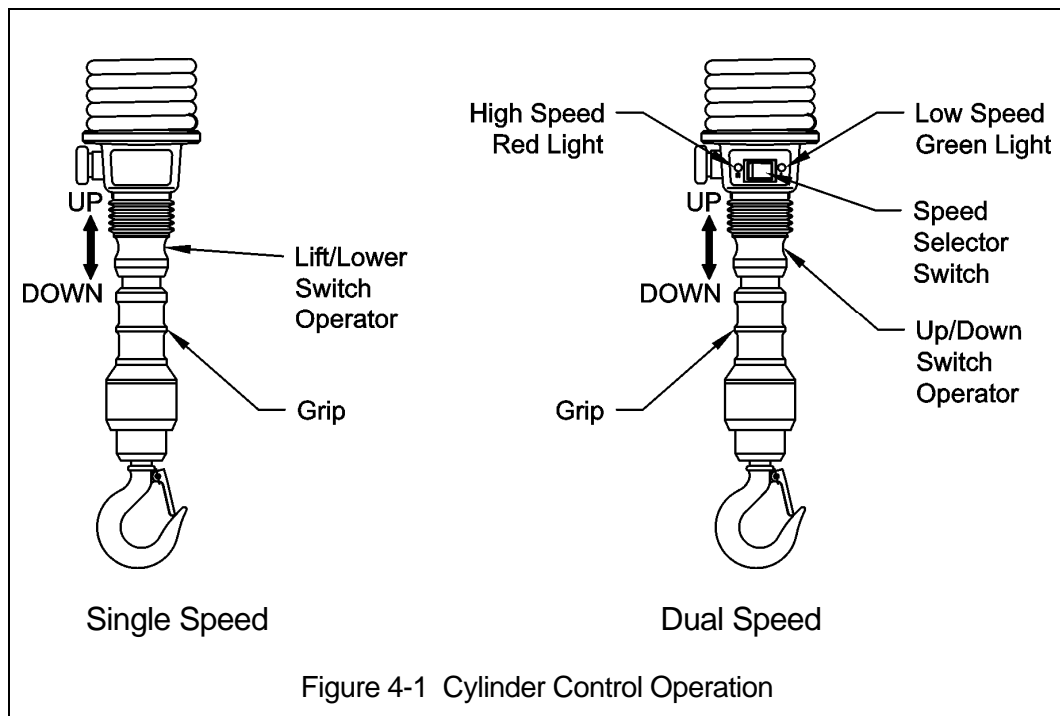

# 9.0 Parts List

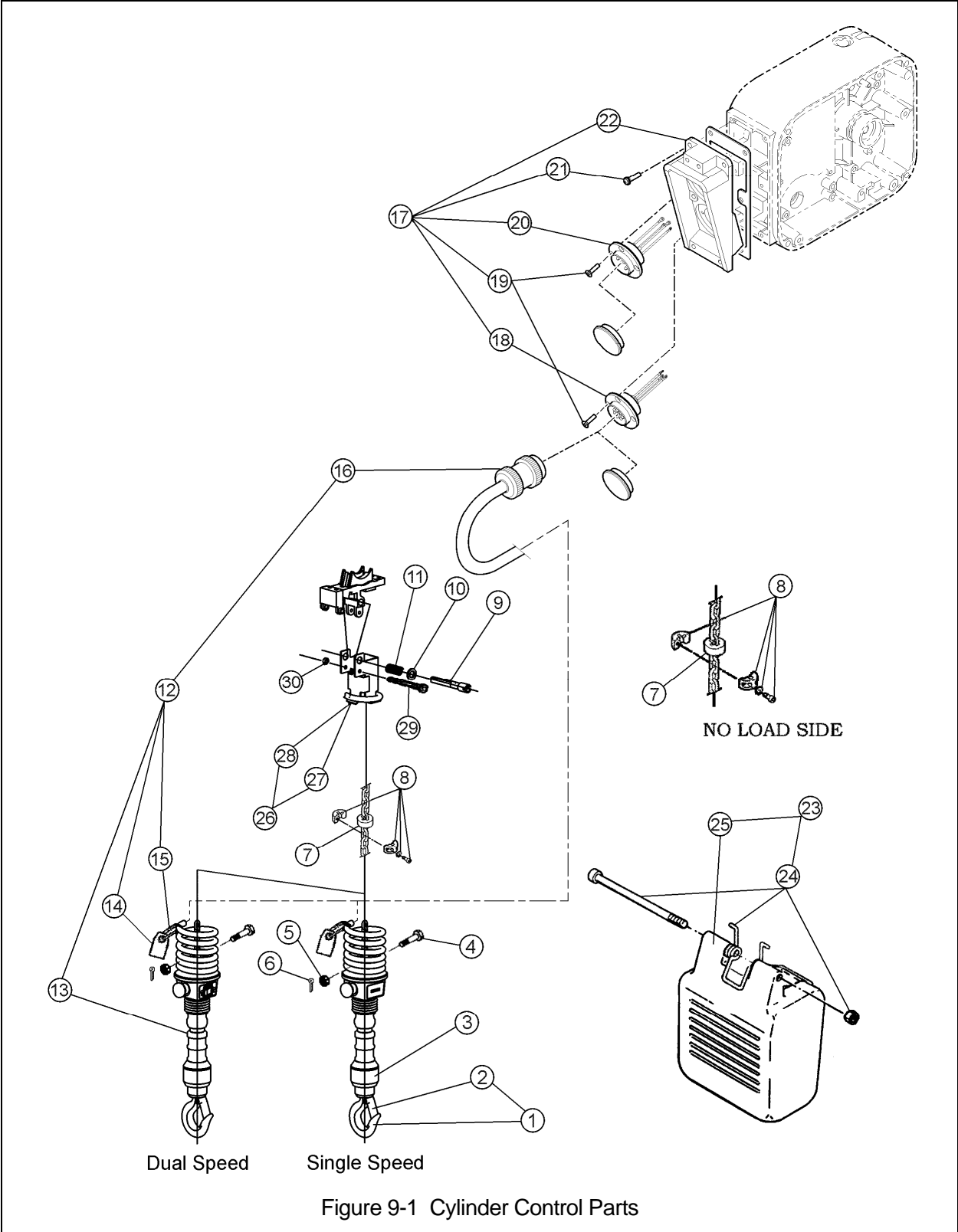

Figure No.	Part Name	Parts per Hoist	Part Number
1	Detachable Hook Assy	1	CD1B11011
2	Latch Assembly	1	CF071005
3	Detachable Fitting E Complete Set	1	E2D5041125
4	Chain Pin	1	L1LA0059041
5	Slotted Nut	1	L1LA0059049
6	Split Pin	1	E2D096125
7	Cushion Rubber	2	ER2BS9053
8	Stopper Assembly	2	ER1CS1041
9	Lever Pin C	NER2	1 CD2BS9338
	Lever Pin MC	ER2	1 CD2BS9357
10	Collar	1	CD1BS9758
11	Limit lever spring	1	ER2CS9357
12	Cylinder Switch S/D Complete Set	S	1 ZC1002311020
		D	1 ZC3002311020
13	Cylinder Switch S/D Assembly	S	1 SWE2100CD
		D	1 SWE2300CD
14	Warning Tag PB	1	SWD9013AD
15	Tag Holder	1	E3S787003
16	Plug 8P	1	ECP2108AB
17	Socket Frame Complete Set	S	1 CD2BS4511
		D	1 CD2BI4511
18	Socket 8P Assembly	S	1 CD2BS2564
		D	1 CD2BI2564
19	Tapping Flat Head Machine Screw	8	ES558003
20	Socket 4P Assembly	S	1 ER2CS2523
		D	1 ER2CI2523
21	Machine Screw with Spring Washer	2	ES650005S
22	Socket Frame	1	ER2CS9511
23	Chain Container Kit	1	PBK2-B
24	Container Spring Assy	1	ER2BS1416
25	Chain Container Bucket	1	ER2BS1401
26	Cable Support Assy	1	CD2BS1750
27	Cable Support A	1	CD2BS9750
28	Cable Support B	1	CD2BS9751
29	Socket Bolt	1	9091257
30	U Nut	1	ES855003

S = Single Speed  
D = Dual Speed



[www.harringtonhoists.com](http://www.harringtonhoists.com)

Harrington Hoists, Inc.  
401 West End Avenue  
Manheim, PA 17545-1703  
Phone: 717-665-2000  
Toll Free: 800-233-3010  
Fax: 717-665-2861

Harrington Hoists – Western Division  
2341 Pomona Rincon Rd. #103  
Corona, CA 92880-6973  
Phone: 909-279-7100  
Toll Free: 800-317-7111  
Fax: 909-279-7500

**ER2CYLSUP**